

straightcurve®

# Specifications

## 400mm Rigidline™

LENGTH 2160mm | TOP THICKNESS 8mm

### FINISHES

- Galvanised Steel
- Weathering Steel

### SOLD AS SET INCLUDING

- 1 x Joining set (3 x wedge, 3 x slider, 1 x joint bracket)
- 5 x galvanised spikes, 300mm long
- 2 x bracing ribs (attached to edge)

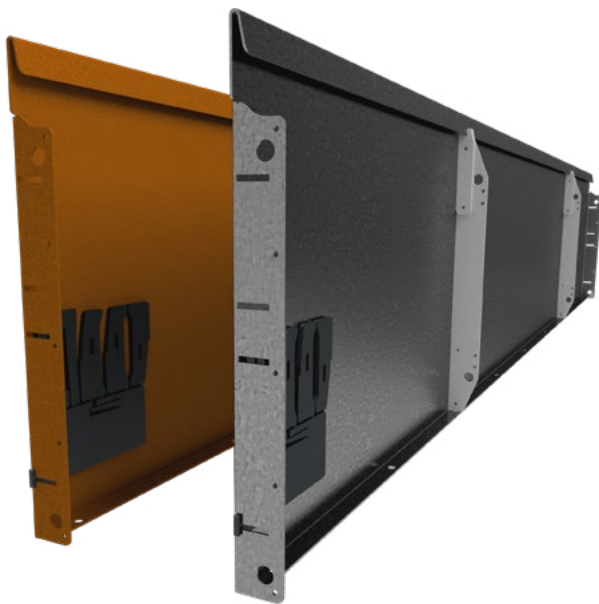
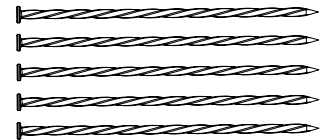
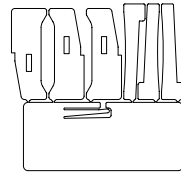

Steel plate thickness 2mm

### ADDITIONAL ACCESSORIES

#### REQUIRED

- Universal bracing set OR
- Large anchor post (4 x Tek Screws 12G x 16mm)

#### OPTIONAL

- Corner piece (arm lengths: 255mm)
- Joining sleeve (8 x Tek Screws 12G x 16mm)

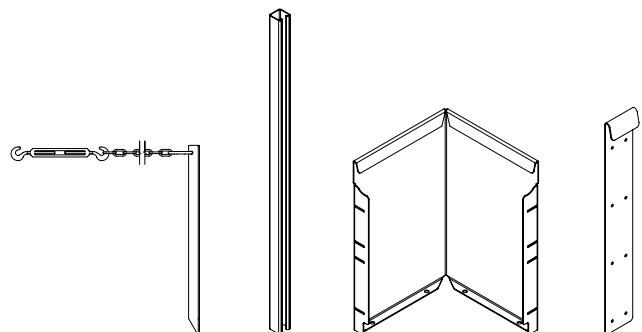

# Installation guide 400mm Rigidline™



## PREPARATIONS

Mark line and level or trench as required ready for install.

## CORNERS

Pre-made corners\* are available for purchase and recommended, these include the standard joining set. These can be opened or closed further with forceful bending to achieve different angle corners. You can also choose to make your own. To do this score a line down the back of the edge and create a sufficient opening (5-7mm) in the folded lip at the top and cut out part of the foot at the bottom with your angle grinder to allow space for bending. Bend strongly by hand; using a block of wood close to the fold to form bend against.

## JOINING SLEEVES

Shortening a length is sometimes a requirement. The joining sleeve is used to connect the two edges when this occurs. These are fixed to the panel front with screws through the guide holes in the sleeve.

## BRACING METHODS\*\*

Two methods for bracing are available. The universal bracing sets will work well in hard ground situations or when quick set concrete is utilised. The anchor posts are more appropriate in soft soil conditions. Both methods allow for adjustment of the vertical during installation - the brace has a turnbuckle while fixing the bracing rib to the large anchor post sets it's vertical.

When terracing, make sure the walls are 1.5x the wall height from each other. As a minimum allow two bracing sets or anchor posts per edge length (except for closed circles of two panels where they are not required).

## TIP

In soft sandy soils, a little quick set concrete around all anchor points makes a huge difference.

STEP 1 - JOIN

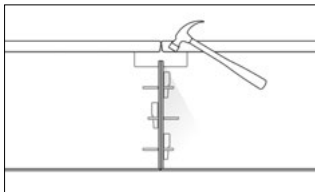

STEP 2 - POSITION

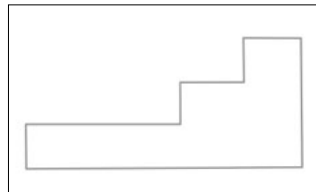

STEP 3 - PEG

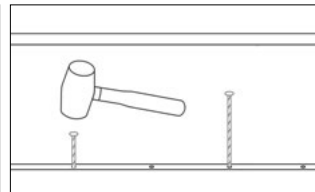

STEP 4 - BRACE\*\*

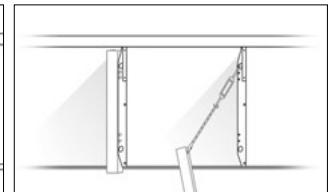

PRE-MADE CORNER\*

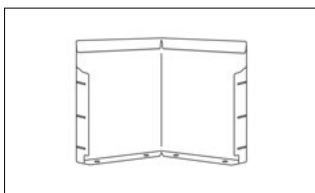

MAKE CORNER - NOTCH/SCORE WITH GRINDER

